

SKELETON ROCK BUCKET

RECOMMENDED APPLICATIONS:

Excellent for quarry work, design allows for sifting of loose debris to fall through to keep material load to minimum.

QUALITY CONSTRUCTION:

High strength steel construction for durability and long wear. Each bucket is engineered with tapered side plates to reduce wear on the buckets sides, and to allow for easier dumping.

STANDARD SIZES:

2.75 cu. yd. to 7.0 cu. yd. of various widths available. Special designs or desired tine spacing is available upon request.

ADDITIONAL FEATURES:

Available with Werk-Brau front coupler or pin-up connection.

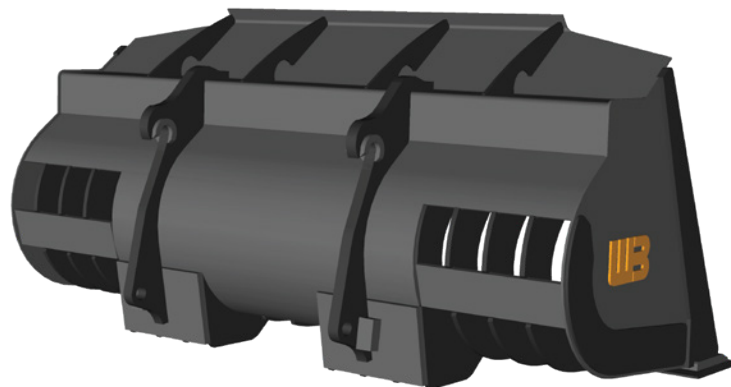
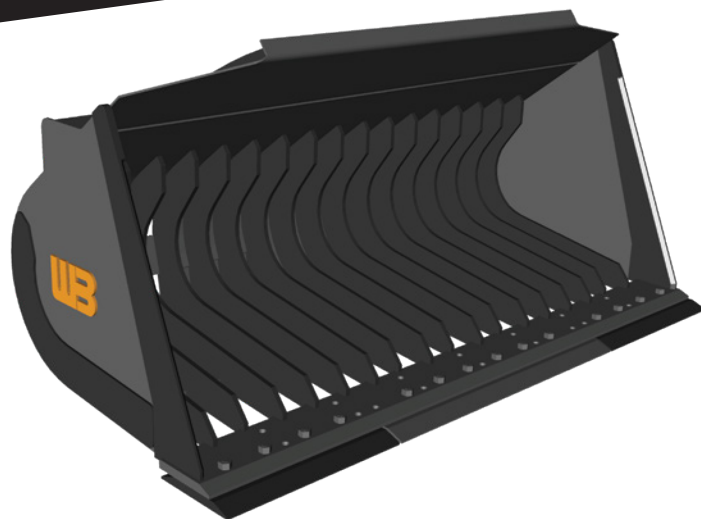

SKELETON ROCK BUCKETS

LOADER CLASS	PART NUMBER	BUCKET WIDTH	EDGE LENGTH	RIB SPACING	CAPACITY STRUCK	CAPACITY RATED	WEIGHT
1	WL1SKL100-2.00	100"	102"	5"	1.69	2.00	2,050
2	WL2SKL100-2.50	100"	102"	5"	2.17	2.50	2,400
3	WL3SKL100-3.00	100"	102"	5"	2.54	3.00	2,900
3.5	WL3.5SKL105-3.50	105"	108"	5"	2.97	3.50	3,600
4	WL4SKL117-4.50	117"	119"	5"	3.81	4.50	4,250
5	WL5SKL124-5.50	124"	126"	5"	4.60	5.50	6,900